

# CONTURA® G2 RDS CONTURA® G2 AKTIV



We make it visible.

# Introducing the next generation scanning platform.

**CONTURA G2 RDS and CONTURA G2 AKTIV: The CMM that brought Active Scanning to small and midsize manufacturers has been redesigned from the ground up to offer greater flexibility and better accuracy. We have been developing and manufacturing the core components of our measuring machines in our own company for more than 30 years.**

## Key benefits

### Scanning Technology

High-speed scanning is the accepted standard for leading-edge performance in precision measurement. Scanning not only saves precious time by capturing large data quantities in a shorter time and increases measuring reliability to improve your part production, but it also permits you to pinpoint production problems. In solving these problems, product quality and reliability will improve.

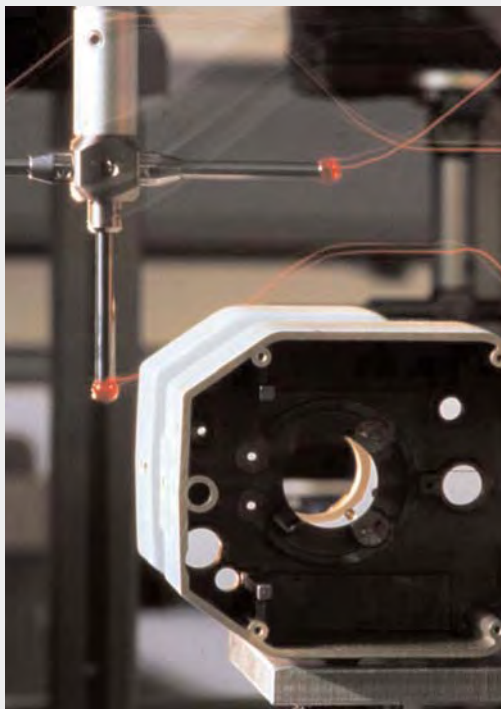

### We Introduced Scanning

Carl Zeiss introduced scanning in the mid-1970s, then created high-speed scanning in 1989. In 1994, "reference-class" measurement performance was transferred to the PRISMO VAST (Variable Accuracy and Speed probing Technology), a shop floor CMM that became the worldwide standard for high-speed scanning. In 2000, this patented technology went mainstream with the introduction of the CONTURA.

Redesigned from the ground up, **CONTURA G2 RDS** and **CONTURA G2 AKTIV** allow you to choose the VAST technology that best suits your applications:

### CONTURA G2 RDS

- Designed for measuring special features, lots of angles, and needing very small styli.
- Best-in-class ZEISS RDS articulating probe holder that can reach 20,376 positions in 2.5° increments.
- Articulating scanning with the VAST XXT.



### CONTURA G2 AKTIV

- Designed for measuring deep features, self-centering, displaced conditions such as reference systems or position errors, and high throughput needs.
- ZEISS Active Scanning with VAST XT for multi-point measurement of size, form, and position.



## Measuring ranges and accuracy

### A variety of measuring volumes

- Five available sizes, increasing for larger tasks:  
X-bridge width at 700 mm or 1000 mm,  
Y length from 700 mm to 2100 mm.

### U-STONE Z-height raised bridge option

- Increases the effective measuring range.
- Z-axis clearance extended an additional 200 mm.

### Optimal precision

- Extremely low dimension errors at ambient temp:  
18-22°C. HTG option increases it to 18-26°C.
- HTG option includes CMM and workpiece  
temperature sensors.

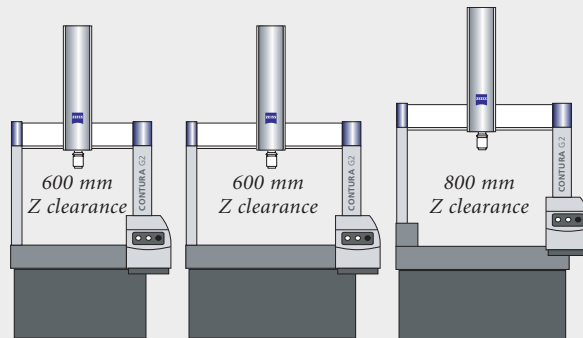

## Machine technology

### Robust design

- Granite table provides a durable and secure surface for your parts.
- Ceramic guideway technology in X and Z offers rigidity and stability against temperature changes, moisture, and other contaminants.
- The measuring scales are less susceptible to dirt and contamination.
- All 3 axes have support with 4-sided air bearings
- Switches for operation type, Emergency Stop, and Start, Run, and Reset.

### CAA (Computer Aided Accuracy)

- Computer-aided error correction of the kinematics for very accurate results.



### Control panel

- Computer independent, standard panel.
- Dual graduated control joysticks for easy and more precise remote control of 3-axis movement.
- Variable speed control in CNC modes.

### C99 controller

- Optimized to machine and sensor.
- ZEISS Active Scanning or touch-trigger and passive scanning.

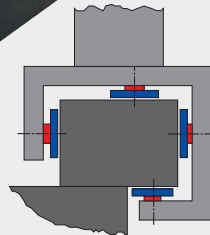

## Software

### CALYPSO CAD-Based Software

- Visual Metrology concept for creating and maintaining measuring plans.
- Intelligent: rules-based programming sets the detailed parameters, automatic paths, and collision avoidance.
- Powerful: supports a wide range of sensors, high-level tools, formulas, and parameters.
- Better performance with scanning technology.

### HOLOS for measuring free-form surfaces

### Teleservice (Optional)

- Onboard diagnostics
- Remote support
- Software updates
- User assistance

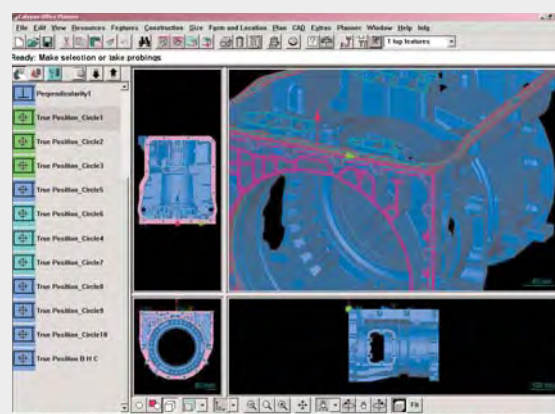

# Your measuring application should determine the choice of CMM.

Choose your CMM platform based on real-world measuring needs. **CONTURA G2 RDS** and **CONTURA G2 AKTIV** give you the same incredible accuracy with a **ZEISS** sensor to fit your requirements.

### Are you measuring...

...special features, parts with lots of angles, or require very small styli? Then you need the **CONTURA G2 RDS** with the best-in-class articulating sensor holder.



Are you measuring deep features, self-centering, displaced conditions such as reference systems or position errors, and need high throughput? Then you need the **CONTURA G2 AKTIV** with its active sensor for higher scanning speed.



### Do you need scanning?

Scanning gives you much better information about your workpiece. Continuous measurement of features and contours provides the high point density needed for determining actual shape. Measurements become more reliable and stable with shorter throughput times.

#### Does it fit or doesn't it?

A mating part may not fit correctly to a bore measured with only 4 points. The calculated circle only provides an idea of its location and a guess as to its functional size. 1000s of points gives you the complete geometry (location, form and size) and allow you to calculate the largest diameter able to fit into the bore.

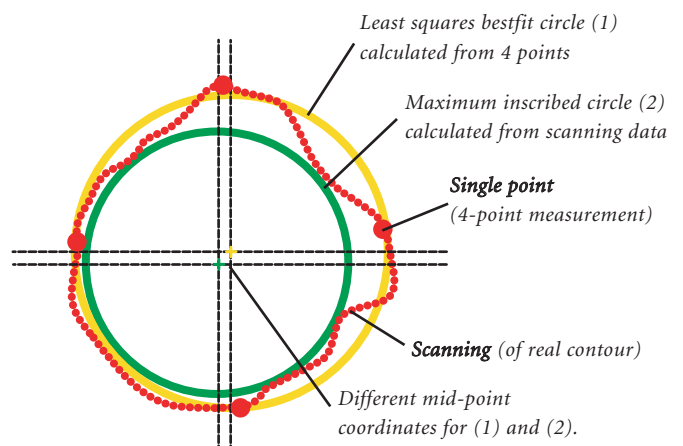

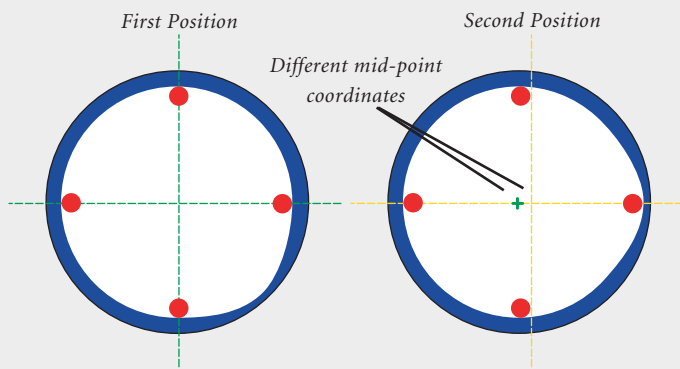

**Single point:** With only a 4-points, a part feature placed in a new position may give you completely different results.

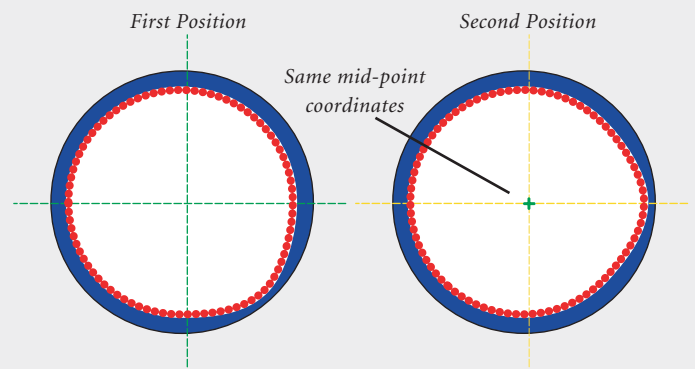

**Scanning:** With 1000s of points, a part feature placed in a new position will give you correct and repeatable results.

### Cylinder Measurements

With its high dispersion and low repeatability, single point measurement yields results of low accuracy. Scanning guarantees results of optimum quality and density due to its low dispersion and high repeatability.

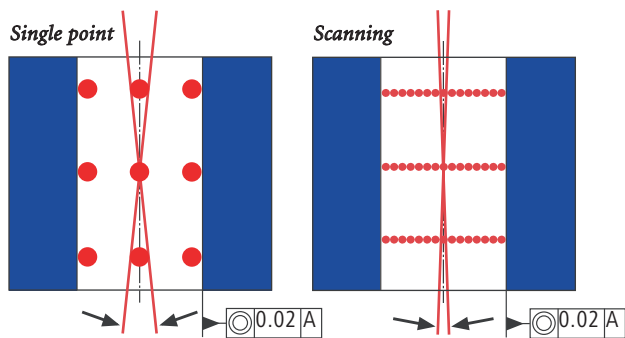

### Form Measurement

Reproducibility for repeat measurements is doubled and discrepancy of any quality results can be considerably reduced for stable results.

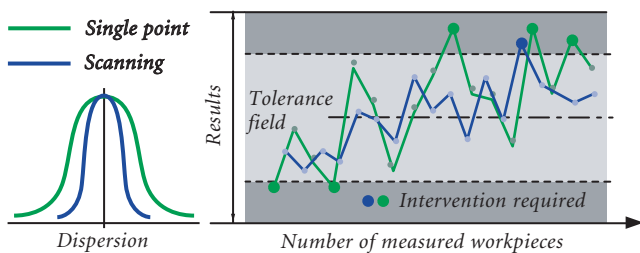

Output form plot with CALYPSO: This example shows the scanned profile of an angled plane relative to a top plane. Results are shown as magnified markers.

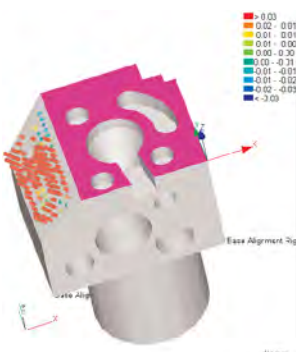

### Segments and Partial Features

When measuring small sections of geometrical elements like spheres, cones, cylinders, and surfaces, scanning provides more stable results. A partial inner radius, for example, using single point measurement can produce a variety of mid-point coordinates. Scanning not only measures it correctly, it also does it faster.

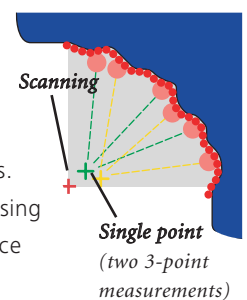

### A Prerequisite for Gage R&R

Alignment can be critical in Gage Repeatability and Reproducibility. When a part is removed and replaced (shown at top), it isn't necessarily placed in the same position—which causes different results when measuring only 4 points. With scanning, even if the part is removed or replaced and not in the same position, you will get correct and repeatable results.

### Key Benefits of ZEISS Scanning

- Fast scanning of form features for prismatic workpieces featuring circles, cylinders, cones, planes and even single point for basic tasks.
- Scanning of known contours for curves and free-form surfaces and unknown contours, ideal for digitizing in tool and moldmaking.
- Self-centering probing for grooves or cavities.
- Automatic selection of scanning speed based on the required accuracy.

# Proven sensor technology optimized for the CMM.



Orchestrated to perfection, each **CONTURA** model offers optimum integration to a **ZEISS** sensor.

## CONTURA G2 RDS

You won't find a more versatile technology than the RDS. The best-in-class articulating probe holder makes it possible to reach virtually all spatial angles with an extremely large number of discrete positions. This is especially beneficial for measuring intricate parts that normally require probes configured for many spatial directions.

A part is checked using only one probe and one clamping setup. Few probe combinations means simple parts programming, increased throughput rates and reduces idle time.

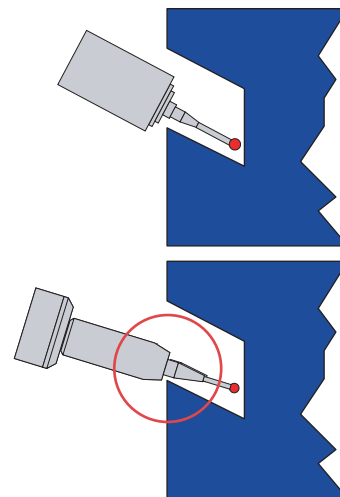

*RDS can be oriented to an angled feature with articulating increments of **2.5°** and **20,736** indexing positions with an accuracy of  $\pm 1$ sec.*

*Conventional indexing can lead to inaccessible measurements and collisions with articulating increments of **7.5°** and fewer indexing positions.*

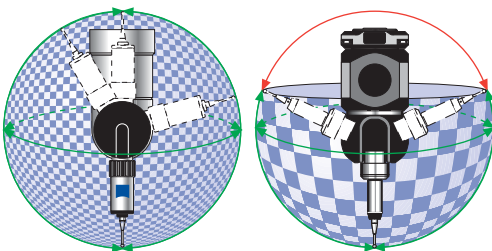

*RDS provides  $\pm 180^\circ$  swivel range of motion. Conventional indexing has a  $130^\circ$  inaccessible zone.*



### VAST XXT Sensor

We've combined our high-accuracy VAST scanning technology with the flexibility of the RDS. As a replacement for trigger sensors, the VAST XXT offers unmatched measurement capability, reliability, and accuracy. With a large deflection range and low measuring force, it is a very robust scanning sensor.

- Use styli lengths up to 250 mm, side and star styli (sideways up to 40 mm), and a minimum ball radius of 0.3 mm. VAST XXT has very low measuring forces and there is little influence when swiveling.
- Choose from two sensor modules (30-125 mm and 125-250 mm). There is less to calibrate with more effective CNC runs.
- Digital signal transmission provides reliable and accurate operation.
- Large 25 mm diameter stylus plates provide the highest repeatability.
- Large  $\pm 3.0$  mm range of deflection offers the most effective collision protection
- Automatic features, such as module detection stylus tip changer (optional, shown above).



### Application Examples

- Digitizing and measuring small blades with high curvature.
- Measuring slots in many positions—form with scanning and position.
- Measuring of watch housing with 0.6 mm holes using 0.3 mm stylus radius.



**Measure very small parts & 2D features:**  
RDS with ViScan brings optical image analysis to the CONTURA G2 RDS. It measures geometries at different heights with single-point, scanning, or cross-hair methods.



## CONTURA G2 AKTIV

For active single-point measuring, configure the CONTURA G2 AKTIV with the high-performance DynaTouch (DT) sensor. For the benefits of ZEISS Active Scanning, select VAST XT.

### DT Sensor

- DT measures using an integrated dynamic system. It is much more reliable, robust and reproducible than conventional single-point systems which are more sensitive to variations in materials, stylus geometries, or ambient conditions.

- DT permits flexible use of complex stylus configurations. Automatic weight balancing lets you mount heavy styli (up to 500 g) or even one-sided loads. Probe deep bores using long extensions, up to 500 mm in any direction. Or, measure tiny features with very small tips...as small as 0.5 mm. Multiple styli can be used in a single probe combination.
- DT has a self-centering feature that allows you to measure a specific point at the bottom of a feature, like a V groove or radius, to accurately measure the characteristic.
- DT has an affordable upgrade path to VAST XT. The sensor fits the same mounting socket, holds the same stylus combinations and weights, the stylus adapter plate and magazine are identical, and measuring runs are created and evaluated using the same software.







#### VAST XT Sensor

VAST XT is suitable for all applications in curve and free-form metrology and reverse engineering.

- **VAST XT** offers Active Scanning and single-point measuring. With its high-speed, high-point density capability, VAST XT can handle virtually any task, including form inspection, scanning of curves and free-form surfaces, digitizing for reverse engineering, and more.
- **VAST XT** is active because it monitors probe head deflection continuously. A consistently low measuring force is generated, controlled, and applied by the probe to reduce dynamic influences, such as stylus bending.
- **VAST XT** gives you the same capabilities as the DT, such as flexible use of complex stylus configurations, self-centering capability, etc.

#### Application Examples

- Aircraft Engine Air Foils (vanes)
- Bearings
- Brake Components
- Cams
- Castings
- Crankshafts
- CV Joints
- Cylinder Blocks
- Cylinder Heads
- Disk Drive Components
- EDM Parts
- Electrical Connectors
- Low-Accuracy Dies and Tools
- Medical Implants
- Plastic Moldings
- Styrofoam
- Transmission Components
- Wheels

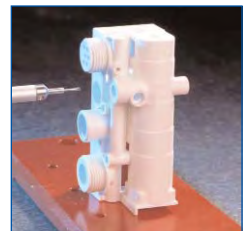

# Highest performance in tough measuring conditions.

**CONTURA G2 has the advanced CMM features and design strengths to handle your tasks.**

## Machine Features

- All axes are equipped with 4-sided Carl Zeiss air bearings to provide more stability and very precise measurement.
- Ceramic guideways are thermally stable—temperature fluctuations have practically no influence on the reliability of the results.
- The **C99 Controller** offers Computer Aided Accuracy (CAA) for real-time dynamic correction of the CMM and sensor for very accurate results. CONTURA G2 AKTIV with the VAST XT comes equipped with the **ZEISS Scanning Engine**, ready for Active Scanning.
- The optional, integrated change rack ensures high repeatability and reduces the need for recalibration.
- The HTG (High Temperature Gradient) version provides the same accuracy for a wider range. It includes temperature sensors for the CMM and the workpiece.

## Measuring ranges

The CONTURA G2 is available in a variety of measuring volumes: from 700/700/600 mm up to 1000/2100/600 mm. For larger applications, extend the effective measuring range an additional 200 mm with the U-STONE option. The raised-bridge design increases the Z-axis clearance to 800 mm.



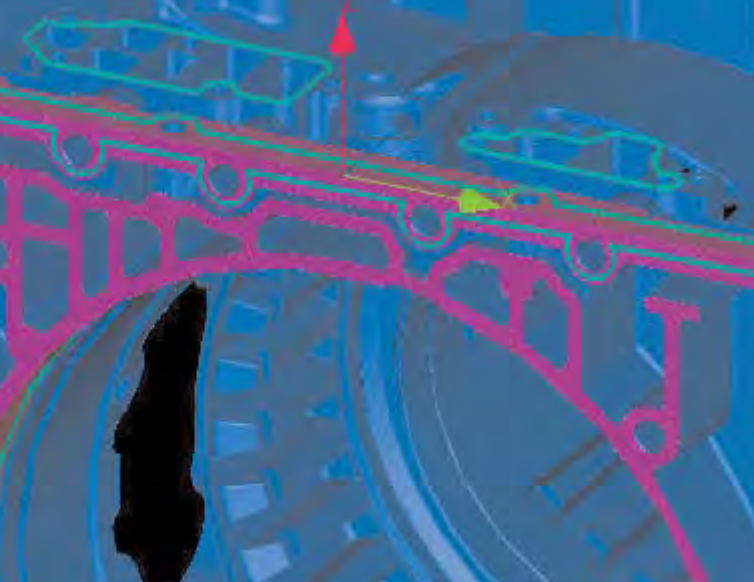

	PM_014_Perpendicularity_A
	PM_015_Flatness
	PM_016_Roundness
	PM_017-PM_019
	PM_017_X-value_Cylinder
	PM_018_Diameter_Cylinder

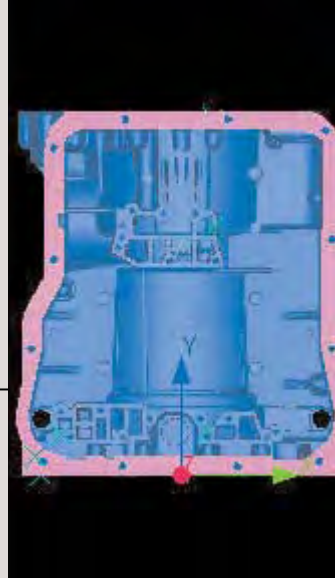

## CALYPSO Software

With Visual Metrology, **CALYPSO** is amazingly simple when creating and maintaining measuring plans. Three essential advantages make it the best choice for your metrology needs:

1. Easy creation of measurement plans with object-oriented programming. Select the same features that are used in your design drawing.
2. Software and sensor flexibility while measuring: from single-point to scanning to optical measurements.
3. Application-specific output of measuring results. It's easy to customize reports.

Whether for single-point or scanning; manual or CNC; on a CMM or off-line, touch or optical; standard geometric forms or free-form surfaces —**CALYPSO** allows you to complete all of your measuring tasks with one software.

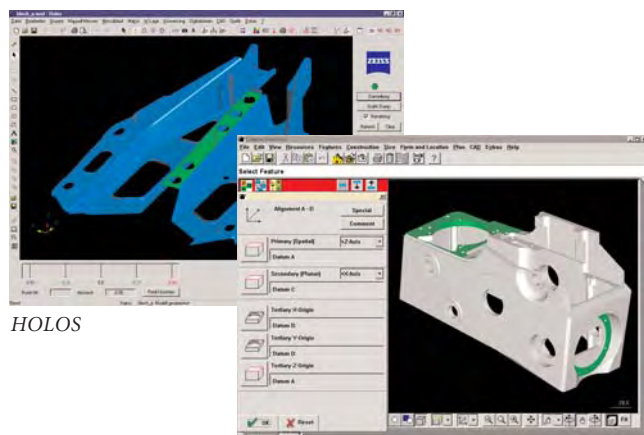

HOLOS

CALYPSO

## CALYPSO and Scanning

**CALYPSO** determines the actual contour of a part for form inspections of standard geometric elements as well as digitizing design models. Scanning is the most reliable method, especially when workpieces have to be inspected for their fitting behavior. **CALYPSO** displays the type of form deviation so precisely that you can see possible deviations or use existing tolerances.

## HOLOS

Measure and digitize free-form surfaces and standard geometric forms without a CAD workstation. **HOLOS** is perfect for tool manufacturing and mold making, as well as for the forging, plastic, and automobile industries.



Carl Zeiss  
Industrielle Messtechnik GmbH  
D-73446 Oberkochen  
Germany  
Sales: +49 73 64 20 63 36  
Telefax: +49 73 64 20 38 70  
E-Mail: [imt@zeiss.de](mailto:imt@zeiss.de)  
<http://www.zeiss.de/imt>

Carl Zeiss  
IMT Corporation  
6250 Sycamore Lane North  
Maple Grove, MN 55369  
Phone: (800) 752-6181  
E-Mail: [imt@zeiss.de](mailto:imt@zeiss.de)  
<http://www.zeiss.com/imt>

For advice, please contact:

60-20-136-e Printed in Germany DBD-TS-XIII/2005 Too  
Subject to change in design and scope and as a result of ongoing technical development. Printed on chlorine-free bleached paper.  
© Carl Zeiss

